

Help Us Become More Eco-Friendly!

Are you currently receiving our promotional flyers and invoices in the mail?
Would you like to receive future PDQ information, UPS tracking and/or
invoice information via e-mail?

Sign up for Q-mail and ZETADOCS today!
It's quicker, easier and it's green!

In an effort to do our part for the environment, PDQ will be working towards cutting back on the amount of paper and printing we use by communicating more via e-mail. In cases where printing is necessary, we will be using recycled paper products whenever possible.

If you have an e-mail address and would be interested in receiving future promotional information (*Q-Mail*), UPS tracking information, and/or invoices (*Zetadocs*) from PDQ via e-mail, let us know. Take a minute to provide us with your desired e-mail addresses below, check the appropriate boxes and fax it back to us. We will then add you to our Q-mail and/or Zetadocs list all in an effort to start becoming more Eco-Friendly. **(You may request as many contacts as you desire to receive our promotions; however, you may only request one (1) contact to receive the UPS tracking information, and the invoices/Zetadocs).**

We will keep all of this information confidential and use it only for the promotion or updating of products sold and represented by PDQ Supply, Inc.

Thank you in advance for working with us in this endeavor.

Contact Name	Title	Company	E-mail Address	Flyers	UPS	Invoices
_____	_____	_____	_____	<input type="checkbox"/>	<input type="checkbox"/>	<input type="checkbox"/>
_____	_____	_____	_____	<input type="checkbox"/>	<input type="checkbox"/>	<input type="checkbox"/>
_____	_____	_____	_____	<input type="checkbox"/>	<input type="checkbox"/>	<input type="checkbox"/>
_____	_____	_____	_____	<input type="checkbox"/>	<input type="checkbox"/>	<input type="checkbox"/>
_____	_____	_____	_____	<input type="checkbox"/>	<input type="checkbox"/>	<input type="checkbox"/>







Fax this form toll free to 800.344.1848
Please write legibly!





**CALL
FOR
PRICING**

* IN ACCORDANCE WITH A.G.A.-C.G.A. REGULATIONS, ALL FLEXIBLE CONNECTORS MUST BE SOLD WITH ATTACHED FITTINGS. PLEASE SELECT FROM THE CHARTS BELOW FOR THE APPROPRIATE OUTSIDE DIMENSION (O.D.), THE FITTING(S) COMBINATIONS, AND THE DESIRED LENGTH. **OUR GAS FLEXES ARE SOLD IN 36", 48" AND 60" LENGTHS. PLEASE SPECIFY ORDER NUMBER PLUS DESIRED FLEX LENGTH.**
(EXAMPLES: 304141-36, 303131-48, 203135-60).



RANGE FLEX CONNECTORS, 5/8" O.D. (1/2" I.D) STAINLESS STEEL WITH FITTINGS

	<u>ORDER #</u>	<u>FITTING COMBINATIONS</u>
	304141	3/4" MIP STEEL X 3/4" MIP STEEL
	303141	3/4" MIP STEEL X 1/2" MIP STEEL
	303131	1/2" MIP STEEL X 1/2" MIP STEEL
	304242	3/4" FIP STEEL X 3/4" FIP STEEL
	303242	3/4" FIP STEEL X 1/2" FIP STEEL
	303232	1/2" FIP STEEL X 1/2" FIP STEEL
	304132	1/2" FIP STEEL X 3/4" MIP STEEL
	304142	3/4" FIP STEEL X 3/4" MIP STEEL
	303142	3/4" FIP STEEL X 1/2" MIP STEEL
	303132	1/2" FIP STEEL X 1/2" MIP STEEL
	30C3132 (safety yellow coated)	1/2" FIP STEEL X 1/2" MIP STEEL
	304144	3/4" FIP STEEL X 3/4" FIP ELBOW

RANGE FLEX CONNECTORS, 5/8" O.D. (1/2" I.D) STAINLESS STEEL WITH VALVES

	304245	3/4" FIP STEEL X 3/4" FIP BALL
	303135	1/2" MIP STEEL X 1/2" FIP BALL
	303145	1/2" MIP STEEL X 3/4" FIP BALL

DRYER FLEX CONNECTORS, 1/2" O.D. (3/8" I.D) STAINLESS STEEL WITH FITTINGS

	203131	1/2" MIP STEEL X 1/2" MIP STEEL
	203232	1/2" FIP STEEL X 1/2" FIP STEEL
	203132	1/2" FIP STEEL X 1/2" MIP STEEL

PRICING STARTS ON PAGE 275

All logos, trademarks, part numbers, photos & illustrations are intended solely for identification.
Items offered for sale are not represented to be manufactured by the company that built the original equipment.

PHONE: 800-843-0903

FAX: 800-344-1848

WEB: www.pdqsupplyinc.com

MISCELLANEOUS

Fittings, Gas Range

For use with 5/8" & 7/8" O. D. Tube (15/16"-16 thread)



#903031
Male Union
15/16" Male Flare x 1/2" M.I.P.
(Tapped 3/8" F.I.P.)



#903041
Male Union
15/16" Male Flare x 3/4" M.I.P.
(Tapped 1/2" F.I.P.)

Fitting, Gas Dryer

For use with 1/2" O. D. Tube



#902031
Male Union
1/2" Male Flare x 1/2" M.I.P.
(Tapped 3/8" F.I.P.)

Fittings, Specialty



661FHD67
3/8" male flare x
7/16" female flare



BAF375
used with
2 wire safety valves
3/8" fine thread

10043

Orifice
(Natural or LP Gas)
(.014 drill size)



Used on
Robertshaw
oven pilots
#40, #41, #42,
#43, #70, #71

581035D0178

Orifice
(Natural or LP Gas)
(.016 drill size)





Used on
Harper Wyman
oven pilots
#5412 #5413,
#5414, #5415

Tubing, Aluminum

50 foot roll



11191-50  1/8"

11193-50  1/4"

11195-50  3/8"

11192-50  3/16"

11196-50  7/16"

Pricing is per 50 foot roll
Place tubing face down in the circle
to determine your tubing size.

Fittings, Compression

All dimensions
are OD tubing size

612 1/8"

613 3/16"

614 1/4"

616 3/8"



Compression
Nut

602 1/8"

603 3/16"

604 1/4"

606 3/8"



Brass
Sleeve

4590-065 1/8"

4590-067 3/16"

4590-069 1/4"

4590-071 3/8"



Male
Break Off

5817S0007

Kit, Universal Safety Valve

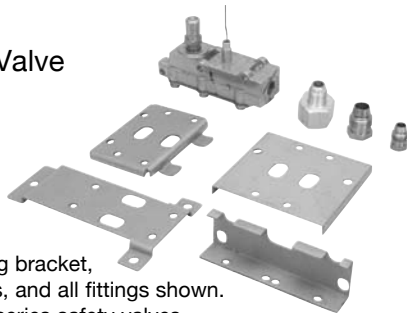



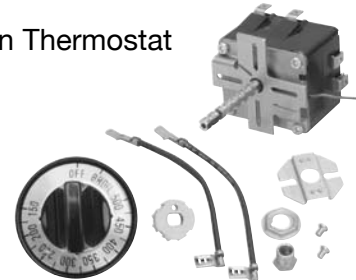

Kit includes: (1) side mounting bracket,
(3) bottom mounting brackets, and all fittings shown.
Will replace 90% of all 5817 series safety valves.

6700S0011

Kit, Electric Oven Thermostat



Mounting Bolts For Thermostats & Burner Valves

Description	Bolts	Application
 BOLT-THRU MOUNTING BOLTS Oven thermostat is tapped to receive mounting bolts directly thru manifold pipe. NO FLANGE NIPPLE IS USED.	601782E01 \$1.25	5362/5363/5392 5393/5396/5397 Class Thermostats
 A= 1/2" B= 1/4" USED ON 95% OF HARPER WYMAN TOP BURNER VALVES	180022E01 \$1.25	Top Burner Valves
 A= 5/8" B= 3/16" USE ON 1832, 1836, 1842, 1846 M SERIES MINI	183009E01 \$1.25	Top Burner Valves
 A= 1/2" B= 1/4" USE ON BOLT-THRU TOP PILOT ASSEMBLIES	700051E01 \$1.25	Top Pilot Assemblies

PRICING STARTS ON PAGE 275

All logos, trademarks, part numbers, photos & illustrations are intended solely for identification.
 Items offered for sale are not represented to be manufactured by the company that built the original equipment.
 PHONE: 800-843-0903 FAX: 800-344-1848 WEB: www.pdqsupplyinc.com

4590211

Kit, Gas Range Knob
Black

Can be used on STANDARD or REVERSE-D applications

KIT CONTAINS:

- (5) knobs
- (5) short, 4-way white inserts
- (5) long, 4-way black inserts
- (4) blank top burner knob overlays
- (1) oven knob overlay - (low-550°, Broil)
- (1) oven knob low temp overlay - (140-550°, Broil)



4590764

Kit, Electric Range Knob
Black

Can be used on STANDARD or REVERSE-D applications

KIT CONTAINS:

- Knobs: 5
- Inlays:
- Surface 4-CW, 4-CCW Thermostat (150-500° w/ Broil) 1-CW, 1-CCW
- Inserts (5 of each): blue, green, gray, red & yellow



4590022

Knob, Thermostat
Black



standard-D

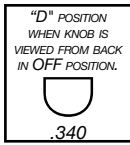

reverse-D



Can be used on STANDARD or REVERSE-D applications

ER3600

Combo, Broiler Pan & Grid

Broiler Pan: 12-1/2" wide x 16-1/2" deep

Grid: 12-3/4" wide x 15-3/8" deep



PWN1214

12-14 gauge

PWN1618

16-18 gauge

Nut, High Temp.
Porcelain Wire



0088050

Clip, Diastat



Used for mounting oven temperature bulb to oven cavity

5303284616

Clip, Diastat



Used for mounting oven temperature bulb to oven cavity

1804C66

Clip, Diastat



Used for mounting oven temperature bulb to oven cavity

40A15

Bulb, Appliance
40w • 115V



Suitable for refrigerators or ranges

ERTB123A

Wrench, Tub Nut



Removes tub nut from washing machine

GGC300

Cleaner, Gas Grate



22 oz.
Removes burnt-on food from grates, cook tops, and bowl pans.

385 surface mount

3890 flush mount

Receptacle, Range

Pass & Seymour



Flush



Surface

50 amp • 120/240 Volt
3 pole • 3 wire

388 surface mount

3860 flush mount

Receptacle, Dryer

Pass & Seymour



Flush



Surface

30 amp • 120/240 Volt
3 pole • 3 wire

PRICING STARTS ON PAGE 275

All logos, trademarks, part numbers, photos & illustrations are intended solely for identification. Items offered for sale are not represented to be manufactured by the company that built the original equipment.

PHONE: 800-843-0903

FAX: 800-344-1848

WEB: www.pdqsupplyinc.com

MISCELLANEOUS

EM241
Motor, Evaporator Fan
(Universal)



CW/CCW Rotation
Shaft diameter: Hub
Shaft length: 3/4"

EM244
Motor, Evaporator Fan
(Universal)

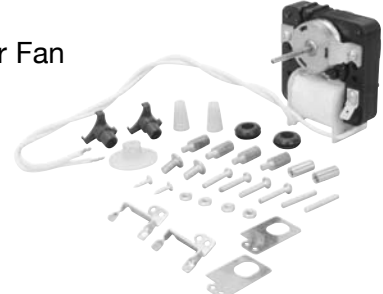

CW/CCW Rotation
Shaft diameter: 1/8"
Shaft length: 1-1/8"

EM245
Motor, Evaporator Fan
(Universal)

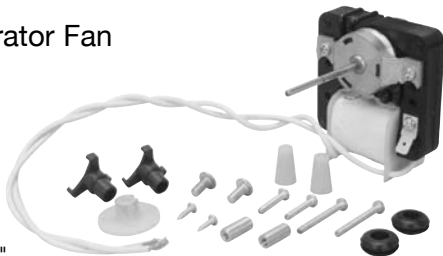

CW/CCW Rotation
Shaft diameter: 1/8"
Shaft length: 1-3/4"

EM247
Motor, Evaporator Fan
(Universal)

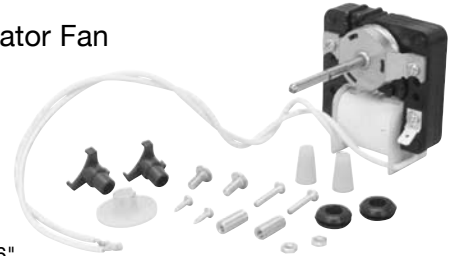

CW/CCW Rotation
Shaft diameter: 3/16"
Shaft length: 1-3/4"

EM248
Motor, Evaporator Fan
(Universal)



CW/CCW Rotation
Shaft diameter: 3/16"
Shaft length: 2-3/4"

EM249
Motor,
Evaporator Fan
(Universal)

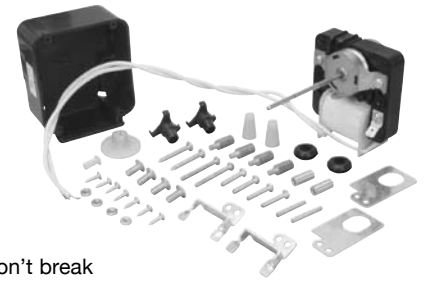

CW/CCW Rotation
Shaft diameter: 1/8"
Shaft length: Break away
Has bolt-on brackets - won't break
where you don't want them

ML45 (CI 45°-CO 25°)
ML50 (CI 50°-CO 30°)
ML55 (CI 55°-CO 35°)
ML60 (CI 60°-CO 40°)
ML70 (CI 70°-CO 50°)
Thermostat, Defrost
(Universal)



10 amp, Has 24" lead wires

215667501
Tray, Ice Cube
12" x 4-1/2"



Heavy duty construction

HS410
Relay, 3-in-1 Hard Start
1/4 - 1/3 HP



Completely pre-wired
Quick & easy installation
Replaces all 3 electrical components:
relay, overload & start capacitor.
Provides additional boost to the
compressor of old refrigerators & freezers.

HS810
Relay, 3-in-1 Hard Start
1/12 - 1/5 HP



Completely pre-wired
Quick & easy installation
Replaces all 3 electrical components:
relay, overload & start capacitor.
Provides additional boost to the
compressor of old refrigerators & freezers.

PRICING STARTS ON PAGE 275

All logos, trademarks, part numbers, photos & illustrations are intended solely for identification.
Items offered for sale are not represented to be manufactured by the company that built the original equipment.
PHONE: 800-843-0903 FAX: 800-344-1848 WEB: www.pdgsupplyinc.com

819043

Heater, Evaporator
Drain Tube



Prevents ice build-up in the drain tube

3609

Heater, Evaporator
Drain Tube

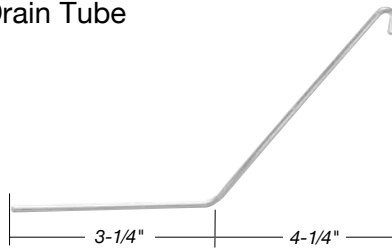

Prevents ice build-up in the drain tube

D103

Drier, Spun Copper



Directional
Regular duty with rubber plug ends
1" diameter, 1/4" inlet, 1/4" outlet

D109

Drier, Spun Copper



Non-Directional
Economy with extended and fused ends
3/4" diameter, 1/4" inlet, 1/4" outlet

D110

Drier, Spun Copper



Directional
Heavy duty with large cup screens for
additional filtration.
Fused and scored ends
3/4" diameter, 1/4" inlet, cap + 1/4" outlet

D111

Drier, Spun Copper



Directional
Heavy duty with Schrader to evacuate
or charge the system.
Fused and scored ends
1" diameter, 1/4" inlet, cap + 1/4" outlet,
3/16" process tube

D112

Drier, Spun Copper



Directional
Heavy duty with large cup screens
for additional filtration.
Fused and scored ends
1" diameter, 5/16" inlet, cap + 5/16" outlet

D113

Drier, Spun Copper



Directional
High capacity service drier with access
fitting tube.
Fused and scored ends
1" diameter, 1/4" inlet, cap + 1/4" outlet,
1/4" process tube

D114

Drier, Spun Copper



Directional
High capacity - Fused and scored ends.
1" diameter, swaged 1/4" inlet, cap +
1/4" outlet

D115

Drier, Spun Copper



Directional
Economy with Schrader to evacuate or
charge the system.
Fused and scored ends
3/4" diameter, 1/4" inlet, cap + 1/4" outlet,
3/16" process tube

1455E

Filler, Porcelain



Fills scratches and dings on your
appliance's porcelain finish.

1125E

white glaze

1126E

white

1440E

bisque

Touch-Up, Porcelain



Lead free, heat proof
Withstands temps to 400°F

PRICING STARTS ON PAGE 275

All logos, trademarks, part numbers, photos & illustrations are intended solely for identification.
Items offered for sale are not represented to be manufactured by the company that built the original equipment.
PHONE: 800-843-0903 FAX: 800-344-1848 WEB: www.pdgsupplyinc.com

MISCELLANEOUS

EBOC

Manual,
Cheap-N-Easy
Oven & Cooktop Repair

Written especially for trade schools,
DIY'ers, and other "green technicians"



EBHR

Manual,
Cheap-N-Easy
Refrigerator Repair

Written especially for trade schools,
DIY'ers, and other "green technicians"



EBGW

Manual,
Cheap-N-Easy
GE/Hotpoint
Washer Repair

Written especially for trade schools,
DIY'ers, and other "green technicians"



EBGD

Manual,
Cheap-N-Easy
GE/Hotpoint
Dryer Repair

Written especially for trade schools,
DIY'ers, and other "green technicians"



EBMW

Manual,
Cheap-N-Easy
Maytag
Washer Repair

Written especially for trade schools,
DIY'ers, and other "green technicians"



EBMD

Manual,
Cheap-N-Easy
Maytag
Dryer Repair

Written especially for trade schools,
DIY'ers, and other "green technicians"



EBWW

Manual,
Cheap-N-Easy
Whirlpool
Washer Repair

Written especially for trade schools,
DIY'ers, and other "green technicians"



EBWM

Manual,
Cheap-N-Easy
Washer Repair

Written especially for trade schools,
DIY'ers, and other "green technicians"



EBHD

Manual,
Cheap-N-Easy
Dryer Repair

Written especially for trade schools,
DIY'ers, and other "green technicians"



EBDW

Manual,
Cheap-N-Easy
Dishwasher Repair

Written especially for trade schools,
DIY'ers, and other "green technicians"



PRICING STARTS ON PAGE 275

All logos, trademarks, part numbers, photos & illustrations are intended solely for identification.
Items offered for sale are not represented to be manufactured by the company that built the original equipment.
PHONE: 800-843-0903 FAX: 800-344-1848 WEB: www.pdqsupplyinc.com

770
Gloves, Disposable



Box of 100 gloves
Light duty unsupported vinyl
Resists most household chemicals
Excellent for painting, refinishing and
general cleaning purposes

775
Gloves, Latex



Medium duty
12" gauntlet cuff
Unsupported rubber latex glove
with flock lining

432
Gloves, Unlined
Leather



Brushed suede cowhide
Straight thumb, gunn cut, taped cuff
Gathered elastic at wrist for a snug fit

7780
Gloves, Canvas



Cotton canvas glove
Straight thumb, clute cut & navy knit cuff

7731
Gloves,
Leather
Palms



Lightweight suede cowhide palms, index
finger, finger tips & knuckle strap
Has wing thumb, gunn cut & cotton back
Gathered elastic strap for a snug fit

7733
Gloves,
Leather
Palms



Heavyweight suede cowhide palms,
index finger, finger tips & knuckle strap
Has wing thumb, gunn cut &
cotton stripped back
Gathered elastic strap for a snug fit

7792
Gloves, Jersey



Men's brown jersey glove
Straight thumb, clute cut and knit cuff

14LJ
Gloves, Jersey



Brown jersey slip-on glove with
red cotton lining
Straight thumb, gunn cut & open cuff

99
Gloves, Gripper



Acrylic knit glove with PVC dots

66
Gloves, Gripper



Knit glove with a textured rubber coating
on the palm & fingertips
Knit wrist to keep out dirt

3025
Rain Poncho



Sized to fit all (50" x 80")
100% waterproof PVC
Carrying pouch included
Comes in 4 colors: hunter green, scarlet red, royal blue, neon orange

PRICING STARTS ON PAGE 275

All logos, trademarks, part numbers, photos & illustrations are intended solely for identification.
Items offered for sale are not represented to be manufactured by the company that built the original equipment.
PHONE: 800-843-0903 FAX: 800-344-1848 WEB: www.pdgsupplyinc.com

MISCELLANEOUS

DVC202

LintEater
12 ft. reach

EXT12FT

Kit, Extention
(4) 36" flexible rods



LintEater

This rotary dryer vent cleaning system easily attaches to your cordless drill and removes lint build-up in your dryer vent. It will safely clean metal, foil and white vinyl dryer vents.

10011WD

WD-40, Smart Straw



spray



stream



11 oz.

Fold straw down for regular spray, fold straw up for stream

56072

Stop, Heavy-Duty
Spring Door
polished brass, 3



EZ-FLO

A102

Trap, Mouse &
Insect (Glue)



Mouse Guard

2 baited disposable glue traps
Non-toxic, non-poisonous, odorless
Child safe, no springs

A402

Trap, Rat &
Mouse Glue

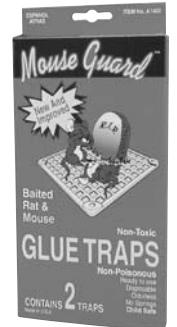

Mouse Guard

2 baited disposable glue traps
Non-toxic, non-poisonous, odorless
Child safe, no springs

10055

Tape, Duct



2" wide x 60 yards
8.5 mil. thickness
Polyethylene coated

73842 stainless steel

73844 brass

Brush, Appliance

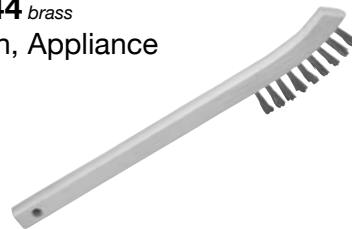

2 x 9 rows of bristles
11/16" trim/length
Curved wood block
Ideal for cleaning appliances, stoves, burners

MILL-ROSE

55405 Tray

55407 Liner

Tray & Liner, Paint

EZ-FLO



Tray and liner are sold separately
Tray is 9" long metal construction
Liner is plastic

55435

Roller, Paint

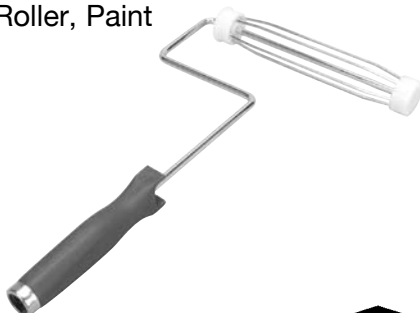

9" paint roller, 5 wire

EZ-FLO

55425 2 wide

55427 3 wide

55429 4 wide

Brush, Paint



Disposable
Wood handle

EZ-FLO

PRICING STARTS ON PAGE 275

All logos, trademarks, part numbers, photos & illustrations are intended solely for identification.
Items offered for sale are not represented to be manufactured by the company that built the original equipment.
PHONE: 800-843-0903 FAX: 800-344-1848 WEB: www.pdqsupplyinc.com