

Part #	Description	Page #	Part #	Description	Page #
4115.....	PAN, BROILER	18	1801L24.....	REGULATOR, PRESSURE	11
4811.....	HINGE, BODY LH.....	17	1801L33.....	REGULATOR, PRESSURE	11
4812.....	HINGE, BODY RH	17	1801M53	BURNER, FRONT.....	14
5292.....	STRAP, SPARK	14	1801M54	BURNER, REAR	14
5686.....	PAN, BROILER	18	1801M58	BURNER, FRONT.....	14
5687.....	SHIELD, GREASE.....	18	1801M59	BURNER, REAR	14
5795.....	GRID, BROILER PAN.....	18	1801M71	CAP, SEALED BURNER.....	14
5900.....	GRATE	14	1802A150	VALVE, SAFETY	10
6268.....	TOP, MAIN	18	1802A205	VALVE, SAFETY	10
6272.....	TOP, MAIN	18	1802A206	VALVE, SAFETY	10
6273.....	TOP, MAIN	18	1802A207	SWITCH, OVEN SPARK	12
6631.....	HINGE, OVEN DOOR	17	1802A223	SWITCH, OVEN SPARK	12
6724.....	BRACKET, ANTI TIP	18	1802A239	VALVE, SAFETY	10
6875.....	HINGE, OVEN DOOR	17	1802A241	THERMOSTAT, OVEN.....	11
6876.....	HINGE, OVEN DOOR	17	1802A247	KNOB, THERMOSTAT	12
7572.....	BACKGUARD	18	1802A248	KNOB, THERMOSTAT	13
1804E28	PIN, COTTER.....	17	1802A290	THERMOSTAT, OVEN.....	11
1842E34	ELEMENT, BROIL.....	16	1802A291	THERMOSTAT, OVEN.....	11
1842E36	ELEMENT, BAKE	16	1802A295	KNOB, THERMOSTAT	12
1842E37	ELEMENT, BAKE	16	1802A298	VALVE, SAFETY	10
1802E48	PILOT, OVEN	10	1802A300	IGNITER, OVEN GLOW	10
1802E67	PILOT, OVEN	10	1802A301	VALVE, SAFETY	10
1802E68	PILOT, OVEN	10	1802A302	THERMOSTAT, OVEN.....	11
1802E76	PILOT, OVEN	10	1802A305	THERMOSTAT, OVEN.....	11
1805E112	PAN, 7" DRIP.....	14	1802A319	THERMOSTAT, OVEN.....	11
1801A133	VALVE, BURNER	12	1802A323	SADDLE MOUNT, TSTAT.....	11
1801A134	VALVE, BURNER	12	1802A326	THERMOCOUPLE.....	10
1801A152	SWITCH, BURNER SPARK	12	1802A330	KNOB, THERMOSTAT	12
1801A153	SWITCH, BURNER SPARK	12	1802A331	KNOB, THERMOSTAT	13
1801A157	VALVE, BURNER	12	1802A332	KNOB, THERMOSTAT	13
1801A159	VALVE, BURNER	12	1802A333	KNOB, THERMOSTAT	13
1801A165	SWITCH, BURNER SPARK	12	1802A338	VALVE, SAFETY	10
1801A166	VALVE, BURNER	12	1802A342	KNOB, THERMOSTAT	13
1801A203	VALVE, BURNER	12	1802A343	KNOB, THERMOSTAT	13
1801A204	SADDLE, MOUNT B/V.....	12	1802A344	IGNITER, OVEN	10
1801A205	SCREW, SADDLE MOUNT.....	12	1802F36	BURNER, OVEN	10
1801B105	MODULE, SPARK.....	11	1802G35.....	RACK, OVEN	18
1801B112	IGNITER, TOP SPARK.....	14	1802G38.....	RACK, OVEN	18
1801B140	STRAP, SPARK	14	1802G39.....	RACK, OVEN	18
1801B142	MODULE, SPARK.....	11	1802I44.....	GASKET, OVEN DOOR.....	17
1801B149	PILOT, TOP DUAL	14	1802I45.....	GASKET, OVEN DOOR.....	17
1801B154	SHIELD, TOP PILOT.....	14	1802I56.....	GASKET, OVEN DOOR.....	17
1801B163	IGNITER, TOP SPARK.....	14	1802I65.....	GASKET, OVEN DOOR.....	17
1801B164	IGNITER, TOP SPARK.....	14	1802I66.....	GASKET, OVEN DOOR.....	17
1801B166	IGNITER, TOP SPARK.....	14	1802I67.....	GASKET, OVEN DOOR.....	17
1801B169	IGNITER, OVEN SPARK	10	1802I68.....	GASKET, OVEN DOOR.....	17
1801B170	IGNITER, OVEN SPARK	10	1803A46	SPRING, OVEN DOOR.....	17
1801B173	MODULE, SPARK.....	11	1803C19.....	PIN, HINGE.....	17
1801B175	IGNITER, OVEN SPARK	10	1803D11	RIVET, ENDCAP.....	18
1801B179	MODULE, SPARK.....	11	1804A62	BOLT, THERMOSTAT.....	11
1801B182	IGNITER, TOP SPARK.....	14	1804C66	CLIP, DIASTAT	17
1801B183	MODULE, SPARK.....	11	1804D5	SPACER.....	17
1801B184	MODULE, SPARK.....	11	1805C52	HANDLE, BROILER	17

PRICING STARTS ON PAGE 275

All logos, trademarks, part numbers, photos & illustrations are intended solely for identification.
 Items offered for sale are not represented to be manufactured by the company that built the original equipment.
 PHONE: 800-843-0903 FAX: 800-344-1848 WEB: www.pdgsupplyinc.com

Part #	Description	Page #
1805C59	HANDLE, OVEN DOOR	17
1805D129	KNOB, BURNER	13
1805D130	KNOB, BURNER	13
1805D135	KNOB, BURNER	13
1805D136	KNOB, BURNER	13
1805D137	KNOB, BURNER	13
1805D141	KNOB, BURNER	13
1805D94	KNOB, BURNER	12
1805D97	KNOB, BURNER	12
1805F222	ENDCAP, BACKGUARD	18
1805F223	ENDCAP, BACKGUARD	18
1805F224	ENDCAP, BACKGUARD	18
1805F225	ENDCAP, BACKGUARD	18
1805L296	HARNESSE, TOP BURNER	12
1841L23	SWITCH, INFINITE	15
1841L28A	BLOCK, TERMINAL	16
1841L30	BLOCK, TERMINAL	16
1841L57A	BLOCK, TERMINAL	16
1841L61	SWITCH, 6 INFINITE	15
1841L62	SWITCH, 8 INFINITE	15
1841M36	ELEMENT, 6" SURFACE	16
1841M36Y	ELEMENT, 6" SURFACE	16
1841M37	ELEMENT, 8" SURFACE	16
1841M37Y	ELEMENT, 8" SURFACE	16
1841N29	PAN, 6" DRIP	16
1841N30	PAN, 8" DRIP	16
1842A18	THERMOSTAT, OVEN	15
1842A40	KNOB, THERMOSTAT	15
1842A54	THERMOSTAT, OVEN	15
1842A56	KNOB, THERMOSTAT	15
1842A57	THERMOSTAT, OVEN	15
1842A58	KNOB, THERMOSTAT	15
1842A59	THERMOSTAT, OVEN	15
1842A60	KNOB, THERMOSTAT	15
1845D33	KNOB, INFINITE	15
1845D40	KNOB, INFINITE	15
1845D41	KNOB, INFINITE	15
1845G63	LIGHT, INDICATOR	16
1845G66	LIGHT, INDICATOR	16
REDLENS	RED LENS, INDICATOR	16

PRICING STARTS ON PAGE 275

*All logos, trademarks, part numbers, photos & illustrations are intended solely for identification.
 Items offered for sale are not represented to be manufactured by the company that built the original equipment.*

PHONE: 800-843-0903 FAX: 800-344-1848 WEB: www.pdqsupplyinc.com

1802A206

Natural gas

1802A205

L.P. gas

Valve, Safety

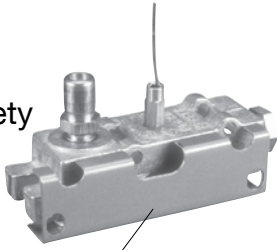

3/8" inlet
Includes mounting bracket

1802A239

3/8" inlet

1802A150*

7/16" inlet

Valve, Safety



*Includes fitting #661FHDG7 to convert from 3/8" to 7/16"

1802A298

Valve, Safety

(3.03-3.3 VAC) • (3.3-3.6 amp)

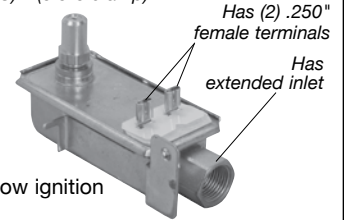

Used on glow ignition wall ovens

1802A301

Valve, Safety

(3.03-3.3 VAC)
(3.3-3.6 amp)

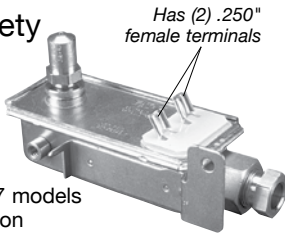

Used on type-7 models with glow ignition
Used with thermostat #1802A302 and oven ignitor #1802A300

1802A338

Valve, Safety

(3.03-3.3 VAC) • (3.3-3.6 amp)

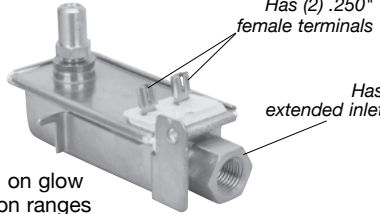

Used on glow ignition ranges

NEW

1802E76

Assembly, Oven Pilot

(Spark Ignition)



1802A326

Thermocouple Only



Both are used with thermostat #1802A319

1802E48

Pilot, Oven

(Standing Pilot)
(R.H. mounting)

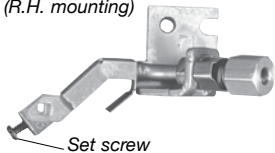

Used with safety valve #1802A150, #1802A239

1802E67

Pilot, Oven

(Standing Pilot)
(L.H. mounting)

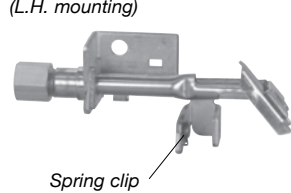

Used with safety valve #1802A150, #1802A239

1802E68

Pilot, Oven

(Spark Ignition)
(L.H. mounting)

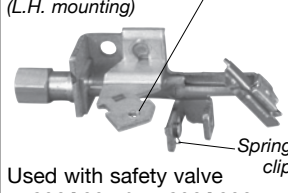

Used with safety valve #1802A205 & #1802A206

Has bracket for mounting oven spark ignitor

1802F36

Burner, Oven

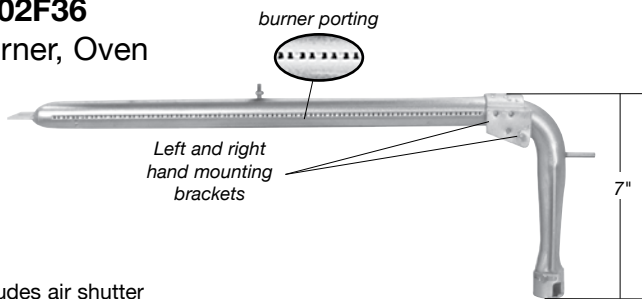

Includes air shutter

1801B169

37" lead wire

1801B170

70" lead wire

1801B175

51" lead wire

Igniter, Oven Spark

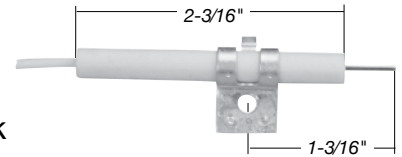

Has a .110" female terminal end

1802A300

Igniter, Oven Glow

17" lead wires
(flat type)

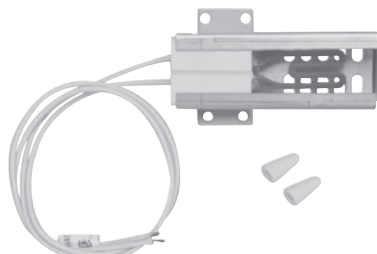

Includes (2) porcelain wire nuts
Has stripped wire ends
Used on type-7 models with glow ignition
Used with thermostat #1802A302 and safety valve #1802A301

1802A344

Igniter, Oven Glow

18-1/4" lead wires
(round type)

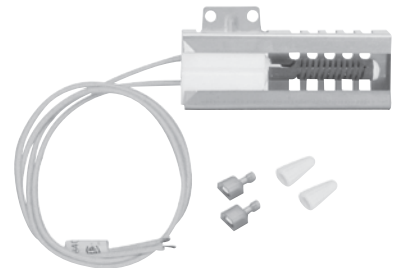

Includes (2) porcelain wire nuts and (2) .250" insulated male terminals
Has stripped wire ends

NEW

PRICING STARTS ON PAGE 275

All logos, trademarks, part numbers, photos & illustrations are intended solely for identification.
Items offered for sale are not represented to be manufactured by the company that built the original equipment.

PHONE: 800-843-0903

FAX: 800-344-1848

WEB: www.pdqsupplyinc.com

1801L24

Regulator, Pressure

(factory i.d. #4670G0032)
1/2" NPT inlet x 1/2" NPT outlet
(4"/10" convertible)
(Set at 10" LP gas)

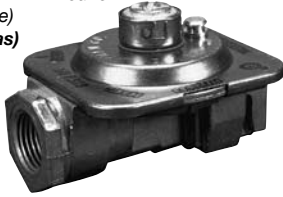

1801L33

Regulator, Pressure

(factory i.d. #4670G0031)
1/2" NPT inlet x 1/2" NPT outlet
(4"/10" convertible)
(set at 4" natural gas)

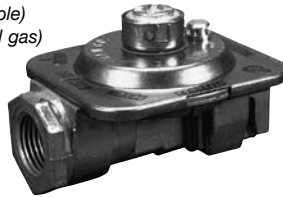

1801B105

Module, Spark

(factory i.d. #6513)
(factory i.d. #977)
2+1

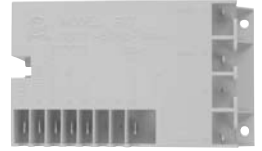

Has (6) .250" & (3) .110" male terminals

1801B142

Module, Spark

(factory i.d. #7087)
(factory i.d. #DG189)
2+1



Has (6) .250" & (3) .110" male terminals

1801B173 2+1

(factory i.d. #6549)
(6) .250" & (3) .110" male terminals

1801B179 4+1

(factory i.d. #6547) (shown)
(6) .250" & (5) .110" male terminals

Module, Spark



1801B183 4+0

(factory i.d. #46328041-001)
(2) .250" & (4) .110" male terminals

1801B184 2+0

(factory i.d. #26328041-001)
(2) .250" & (2) .110" male terminals

Used on type-7 models
with glow ignition

Module, Spark



1802A302

Thermostat, Oven

(factory i.d. #6460G0018)
(factory i.d. #6460G0014)



120 volt - 2 wire
Used on type 7 models
with glow ignition.
Used with safety valve #1802A301
and oven ignitor #1802A300

1802A305

Thermostat, Oven

(factory i.d. #E/G5 275-3471-00)



125 volt - 2 wire
Has (2) .250" male terminals
Used on type 7 models
with glow ignition
Used with oven knobs
#1802A333, #1802A343

1802A319

Kit, Oven Thermostat

1 Outlet
(standing pilot)
(saddle mount)

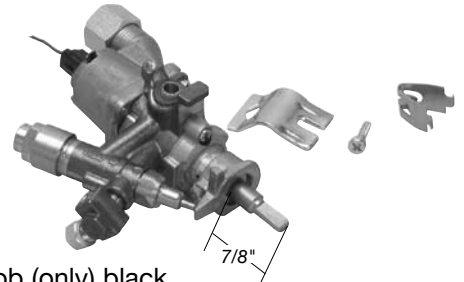

Bolts go thru the
manifold pipe and thread
directly into thermostat

- 1802A332** Knob (only) black
- 1802A342** Knob (only) white
- 1802A326** Thermocouple (only)
- 1802E76** Pilot, Oven (only)
- 1802A323** Mount, Thermostat (only)

1802A241

Thermostat, Oven

(factory i.d. #ELO)
(standing pilot)
(spring clip mount)

Bolts go through
the thermostat &
thread into spring
clips on the
manifold pipe

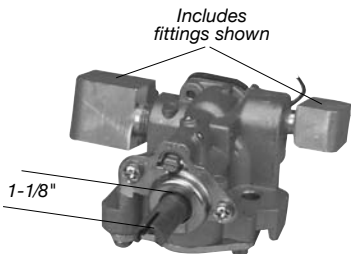

*Red "O" Ring on inlet of thermostat body

1802A290

Thermostat, Oven

(factory i.d. #5362G0013)
3 Outlets
(standing pilot)
(bolt thru mount)

Bolts go thru the
manifold pipe and
thread directly
into thermostat

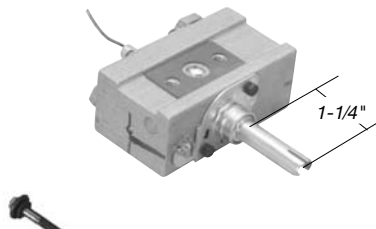

Bolts - #1804A62
Flange Nipple - None

Newer style
with full on-off
cycling broil

1802A291

Thermostat, Oven

(factory i.d. #5396G0017)
2 Outlets
(spark ignition)
(bolt thru mount)

Bolts go thru the
manifold pipe and
thread directly
into thermostat

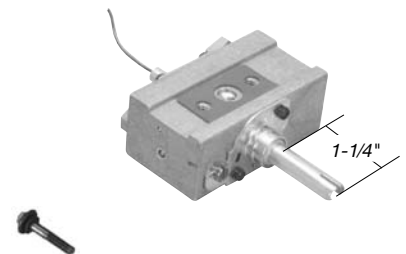

Bolts - #1804A62
Flange Nipple - None

Newer style
with full on-off
cycling broil

PRICING STARTS ON PAGE 275

All logos, trademarks, part numbers, photos & illustrations are intended solely for identification.
Items offered for sale are not represented to be manufactured by the company that built the original equipment.
PHONE: 800-843-0903 FAX: 800-344-1848 WEB: www.pdgsupplyinc.com

1801A133
1801A134
 Valve, Burner
 90° shaft rotation

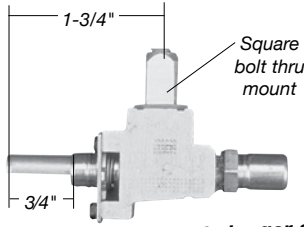

180022E01
 Bolt & Gasket (only)



No longer available from the OEM. Originals still available from PDQ.

1801A157
 90° shaft rotation
1801A159
 180° shaft rotation
 Valve, Burner

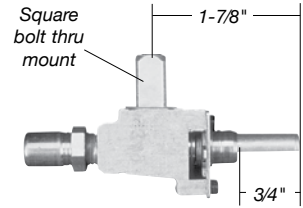

180022E01
 Bolt & Gasket (only)



1801A166
 Valve, Burner
 90° shaft rotation
 (vertical mounting)

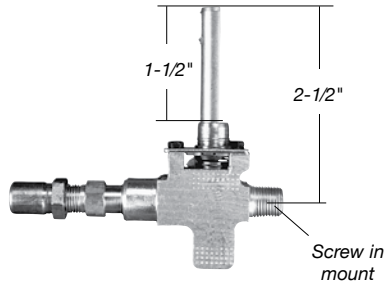

Used on gas cooktops

1801A203
 Valve, Burner
 270° shaft rotation

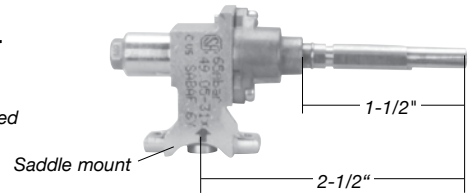

1801A204 Saddle (only)
1801A205 Screw (only)



1801A152
 Light red insert
1801A153
 Light green insert
1801A165
 Dark blue insert
 Switch, Top Burner Spark

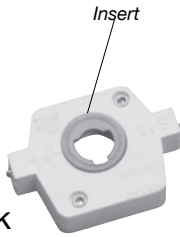

All have standard "D" inserts (.340")

1802A207
 Black insert
1802A223
 White insert
 Switch, Oven Spark



All have standard "D" inserts (.340")

1805L296
 Harness, Top Burner Spark Switch

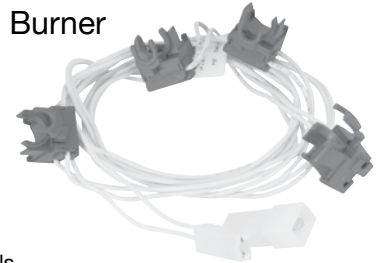

Used on 2006
 20", 24", 30" & 36"
 spark ignition models

1802A247
 Knob, Thermostat
 (flush shaft)



1802A295
 Knob, Thermostat
 (flush shaft)

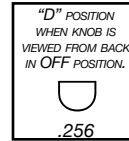

Used with thermostat #1802A302

1802A330
 Knob, Thermostat
 (flush shaft)

NEW

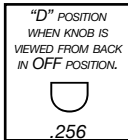

1805D94
 Knob, Burner
 (flush shaft)

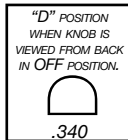

Generic replacement for older styles which are no longer available.

1805D97
 Knob, Burner
 (1/2" extended shaft)

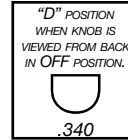

PRICING STARTS ON PAGE 275

All logos, trademarks, part numbers, photos & illustrations are intended solely for identification. Items offered for sale are not represented to be manufactured by the company that built the original equipment.

PHONE: 800-843-0903

FAX: 800-344-1848

WEB: www.pdqsupplyinc.com

1802A248

Knob, Thermostat
(flush shaft)

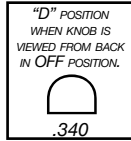

1805D130

Knob, Burner
180° rotation
(5/16" extended shaft)

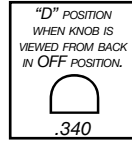

1805D129

Knob, Burner
90° rotation
(5/16" extended shaft)



1802A331

Knob, Thermostat
(flush shaft)

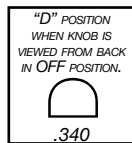

Glossy black finish

1805D136

Knob, Burner
180° rotation
(5/16" extended shaft)

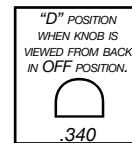

Glossy black finish

1805D135

Knob, Burner
90° rotation
(5/16" extended shaft)



1802A332

Knob, Thermostat
(3/16" extended shaft)

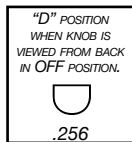

Glossy black finish

1802A333

Knob, Thermostat
(1/8" extended shaft)

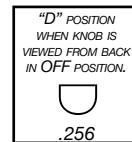

Glossy black finish

1805D137

Knob, Burner
(3/16" extended shaft)



1802A342

Knob, Thermostat
(3/16" extended shaft)

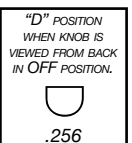

Glossy white finish

1802A343

Knob, Thermostat
(1/8" extended shaft)

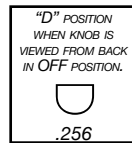

Glossy white finish

1805D141

Knob, Burner
(3/16" extended shaft)



BROWN

GAS SECTION

PRICING STARTS ON PAGE 275

All logos, trademarks, part numbers, photos & illustrations are intended solely for identification. Items offered for sale are not represented to be manufactured by the company that built the original equipment.

PHONE: 800-843-0903

FAX: 800-344-1848

WEB: www.pdgsupplyinc.com

1801B112
Ignitor, Top
Burner Spark
60" lead wire



5292
Strap, Spark only
(must order separately)

1801B163
66" lead wire

1801B164
66" lead wire

1801B166
66" lead wire

Ignitor, Top Burner Spark

1801B140
Strap, Spark only
(must order separately)

.110" female terminal end

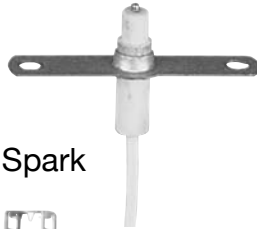

1801B182
Ignitor, Top
Burner Spark



"Sealed burner type"

1801B149

(19-5/8" overall) (used on 36" models)

Harness, Top Pilot
Double Tube



1801B154
Shield, Pilot

1805E112
Pan, Drip



No longer available from
the OEM. Originals still
available from PDQ.

7" diameter

5900
Grate

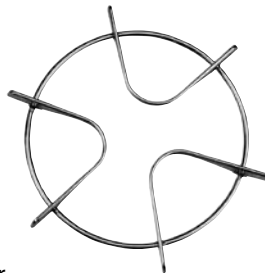

1" height
6-5/8" diameter

1801M71
Cap, Sealed Burner

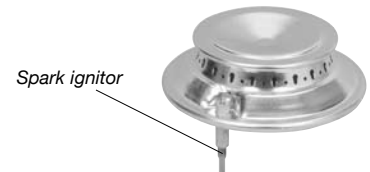

Spark ignitor

3-1/4" diameter base

1801M54
Assembly,
Rear Burner
(replaces 1801M44)

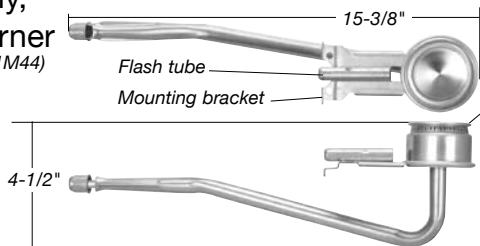

burner head porting

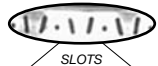

(Both are used on Harper
Wyman/Burner Systems styles)

1801M53
Assembly,
Front Burner
(replaces 1801M45)

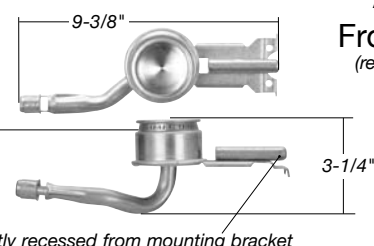

Flash tube slightly recessed from mounting bracket

1801M59
Assembly,
Rear Burner

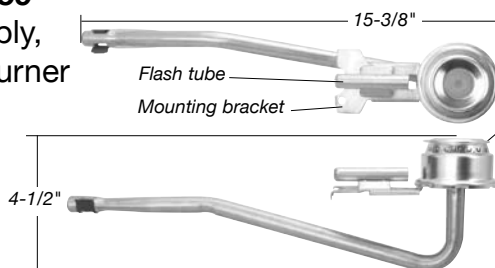

burner head porting



(Both are used on
Lincoln/Mueller Brass styles)

1801M58
Assembly,
Front Burner

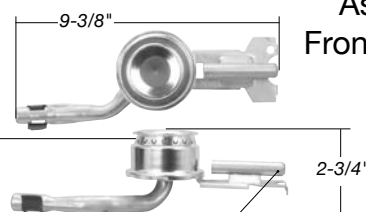

Flash tube slightly recessed from mounting bracket

PRICING STARTS ON PAGE 275

All logos, trademarks, part numbers, photos & illustrations are intended solely for identification.
Items offered for sale are not represented to be manufactured by the company that built the original equipment.
PHONE: 800-843-0903 FAX: 800-344-1848 WEB: www.pdqsupplyinc.com

1842A18

Thermostat, Oven
 (factory i.d. #6703G0007)
 4 Terminals
 240V
 15 amp
 single pole, variable broil

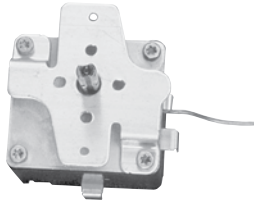

Brown subs this part to a #1842A57.
 "Originals" are still available from PDQ while supplies last.

1842A54

Thermostat, Oven
 (factory i.d. #6713G0021)
 6 Terminals
 240V
 15 amp
 double pole variable broil

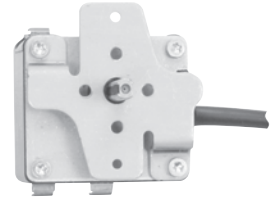

Brown subs this part to kit #1842A57.
 "Originals" are still available from PDQ while supplies last.

1842A57

Kit, Oven Thermostat
 (factory i.d. #275-3492-00)
 (factory i.d. #275-3509-00)
 7 Terminals
 125/250V
 22 amp
 Kit includes knob

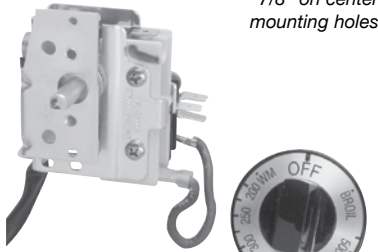

7/8" on center mounting holes

1842A56

Knob, Thermostat (only)



1842A59

Thermostat, Oven
 (factory i.d. #275-3493-00)
 7 Terminals
 125/250V
 22 amp

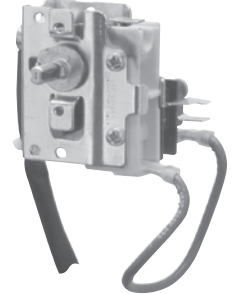

1-1/2" on center mounting holes
 for ranges built after August 2003.

1841L23

Switch, Infinite
 (factory i.d. #INF240P-714)
 15 amp

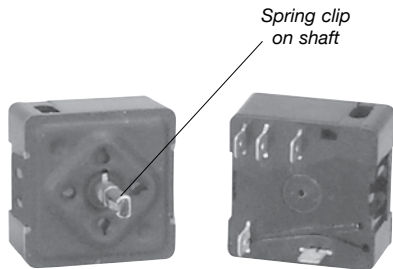

Spring clip on shaft

Universal for 6" and 8" elements

(Voltage sensing type)

1841L61

Used with 6" elements
 (factory i.d. #NL831473)
 (5.2 - 6.25 amps)

1841L62

Used with 8" elements
 (factory i.d. #NL832458)
 (8.8 - 10.8 amps)

Switch, Infinite

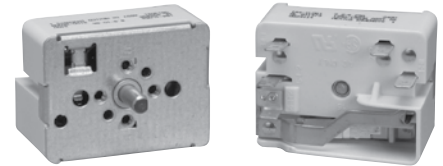

(Current sensing type)

1842A40

Knob, Thermostat
 (flush shaft)



1842A56

Knob, Thermostat
 (flush shaft)

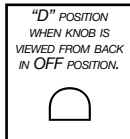

1845D33

Knob, Infinite
 (flush shaft)

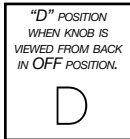

1842A58

Knob, Thermostat
 (flush shaft)

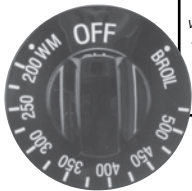

1845D40

Knob, Infinite
 (flush shaft)

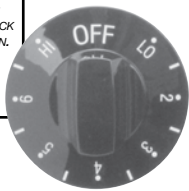
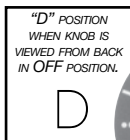

Glossy black finish

1842A60

Knob, Thermostat
 (flush shaft)

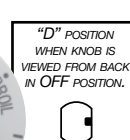

NEW

1845D41

Knob, Infinite
 (flush shaft)

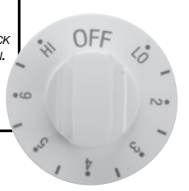
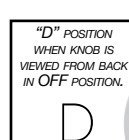

Glossy white finish

PRICING STARTS ON PAGE 275

All logos, trademarks, part numbers, photos & illustrations are intended solely for identification.
 Items offered for sale are not represented to be manufactured by the company that built the original equipment.
 PHONE: 800-843-0903 FAX: 800-344-1848 WEB: www.pdqsupplyinc.com

1841L28A Kit, Terminal Block

Molex Style

Includes:
block, 6" lead wires
with stripped ends,
(2) heat shrink,
(2) wire nuts &
(2) top clips

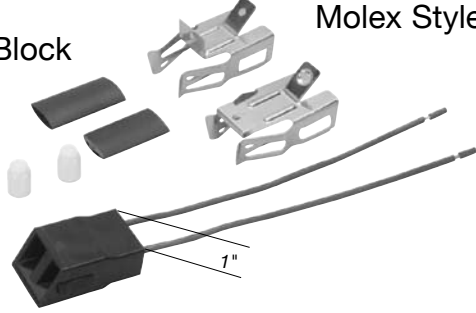

1841L30 Assembly, Terminal Block

Molex Style

Complete terminal block assembly
(70" lead wires with .250" female
crimped flag terminals)

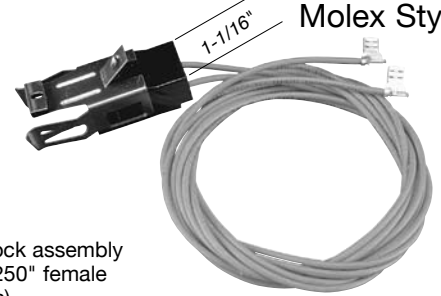

1841L57A Assembly, Terminal Block

Amp Style

Complete terminal block assembly
(45" lead wires with .250" female flag terminal ends)

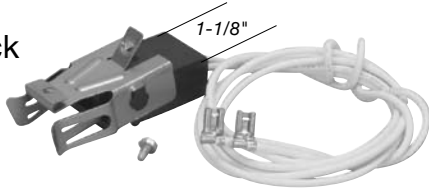

1841N29 Pan, Drip

6"

1841N30 Pan, Drip

8"

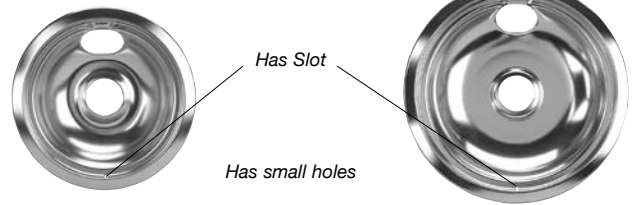

1841M36 Element, Surface

6", (940W@208V)(1250W@240V)

1841M37 Element, Surface

8", (1580W@208V)(2100W@240V)

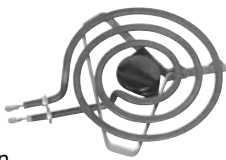

3 Turn
"Delta" bracket



4 Turn
"Delta" bracket

1841M36Y Element, Surface

6", (940W@208V)(1250W@240V)

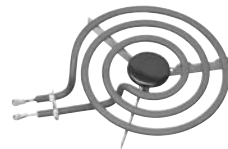

3 Turn
"Y" bracket

1841M37Y Element, Surface

8", (1580W@208V)(2100W@240V)

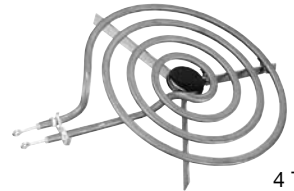

4 Turn
"Y" bracket

1845G63 (shown)

12" lead wires with
(2) .250" male / .250" female piggy back terminals

Both include
replacement red lens

1845G66

9" lead wires with (1) .250" female flag terminal
and (1) .250" male / .250" female piggy back terminal

Light, Indicator



REDLENS

Red lens only (order # is REDLENS)

1842E34 Element, Broil

.250"
male terminal
push-in connection

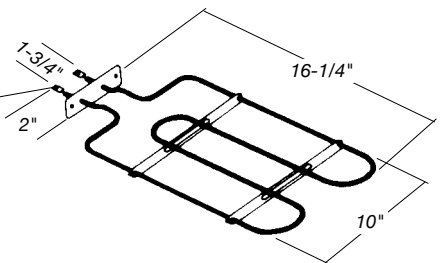

Watts 2500
Volts 240
Used on 20", 24" & 36" ranges

1842E36 Element, Bake

.250"
male terminal
push-in connection

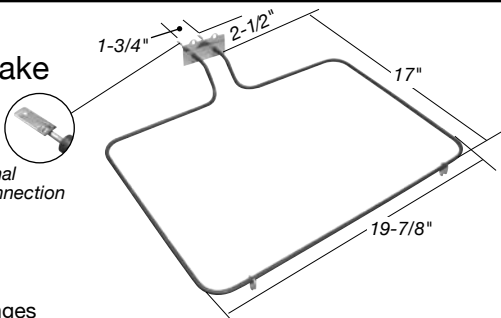

Watts 2600
Volts 240
Used on 30" ranges

1842E37 Element, Bake

.250"
male terminal
push-in connection

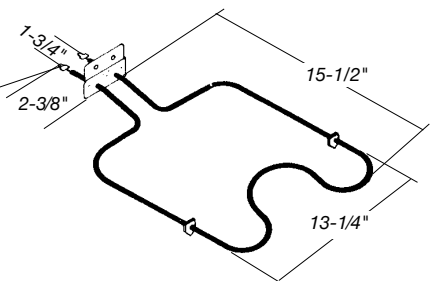

Watts 2000/1500
Volts 240/208
Used on 20", 24" 30" & 36" ranges

PRICING STARTS ON PAGE 275

All logos, trademarks, part numbers, photos & illustrations are intended solely for identification.
Items offered for sale are not represented to be manufactured by the company that built the original equipment.

PHONE: 800-843-0903

FAX: 800-344-1848

WEB: www.pdqsupplyinc.com

1804E28
Pin, Cotter

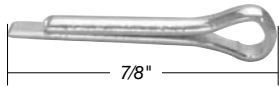

1803C19
Pin, Hinge

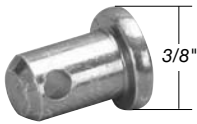

Used with hinges #4811, #4812 & #6631

4811
Hinge,
Oven Body
Left

4812
Hinge, Oven
Body
Right



Used on 24", 30" & 36" gas & electric ranges
Uses cotter pin #1804E28 & hinge pin #1803C19

6631
Hinge, Oven Door
Reversible (left or right)



Uses cotter pin #1804E28 & hinge pin #1803C19
Reversible style hinge, used on lift-off door models: 24" models thru type 35, 30" models thru type 45, & 36" models thru type 30

6875 *Right*
6876 *Left*
Hinge, Oven Door

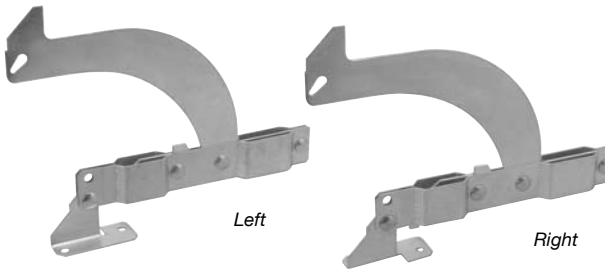

Newest style hinge assembly used on 24" models - type 36 & up, 30" models - type 46 & up, & used on 36" models - type 31 & up.

1803A46
Spring, Oven Door
5-1/4" overall length

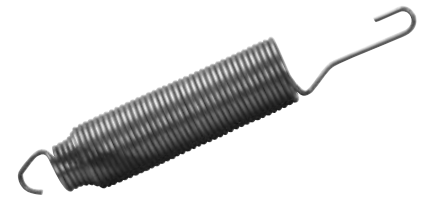

New style used on 24" ranges type 36 & up
New style used on 30" ranges type 46 & up

EBOC
Manual, Cheap-N-Easy
Oven & Cooktop Repair



Written especially for trade schools, DIY'ers, and other "green technicians". See page 179 for more books in this series.

1804D5
Spacer, Handle
White
5/8" diameter
1/4" thickness



1804C66
Clip, Diastat



Used for mounting oven temp. bulb to oven cavity

1802I44 (A) *11-1/2" overall length*
1802I45 (A) *16" overall length*
1802I56 (B) *13-3/8" overall length*
1802I65 (A) *17-1/4" overall length*
1802I66 (A) *18-7/8" overall length*
1802I67 (A) *21-3/8" overall length*
1802I68 (A) *14-5/8" overall length*

Gasket, Oven Door
"Stretch Seals"

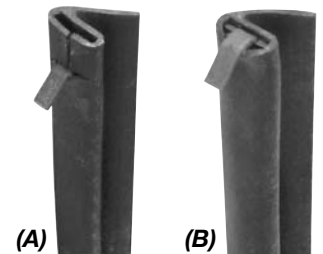

1805C52
Handle, Broiler Door



9" overall length
8" on center holes

1805C59
Handle, Oven Door
Black



16-1/2" overall length
8" & 12" on center holes

PRICING STARTS ON PAGE 275

All logos, trademarks, part numbers, photos & illustrations are intended solely for identification.
Items offered for sale are not represented to be manufactured by the company that built the original equipment.
PHONE: 800-843-0903 FAX: 800-344-1848 WEB: www.pdgsupplyinc.com

1802G35

Rack, Oven

23-3/4" wide x 15-3/4" deep

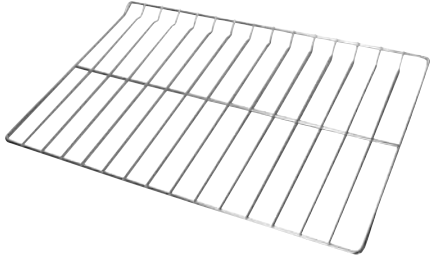

Used on 30" ranges

1802G38

Rack, Oven

15-3/4" wide x 15-3/4" deep



Used on 20" ranges

1802G39

Rack, Oven

18-3/4" wide x 15-3/4" deep

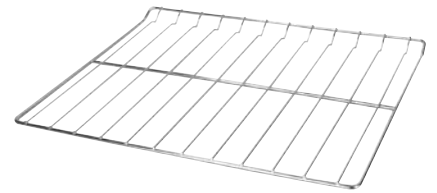

Used on 24" & 36" ranges

4115

Pan, Broiler

11-3/4" wide x 14-3/8" deep

5795

Grid, Broiler

10" wide x 13" deep



*Pan & grid are not sold as a set
Must be ordered separately

Used on electric range models

5686

Pan, Broiler

13-3/4" wide x 17-5/8" deep

5687

Shield, Grease

12" wide x 3-1/2" deep



*Pan & shield are not sold as a set
Must be ordered separately

Old style - 1 piece broiler pan/grid

6268 20" (shown)

6272 24"

6273 30"

Top, Main - Gas

White



Used on gas ranges

7572

Backguard



White
For 30" models
Replaces #5923, no endcaps required

1805F222

Left (shown)

No longer available from the OEM. Originals still available from PDQ.

1805F223

Right

Endcap, Backguard

Used on 24", 30" & 36" ranges

Black finish

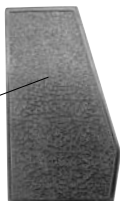

1803D11

Rivet (only)



1805F224

Left

No longer available from the OEM. Originals still available from PDQ.

1805F225

Right (shown)

Endcap, Backguard

Used on 20" gas ranges only
High temperature resistant

Black Finish

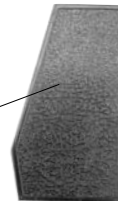

1803D11

Rivet (only)



6724

Kit, Anti-Tip



Bracket is 4-3/4" x 2-1/8"
Kit includes bracket and (2) screws

PRICING STARTS ON PAGE 275

All logos, trademarks, part numbers, photos & illustrations are intended solely for identification.
Items offered for sale are not represented to be manufactured by the company that built the original equipment.
PHONE: 800-843-0903 FAX: 800-344-1848 WEB: www.pdqsupplyinc.com

***If there are any parts you need,
but do not see them here, call us with
your appliance model number(s)
and we will find the parts you need.***

PDOQ[®]
offers you...

- Below Factory Direct Pricing
- Same Day Shipping
- Free Shipping on All Qualifying Orders Over \$50.00
- Toll Free Ordering
- Knowledgeable, Courteous Sales Staff

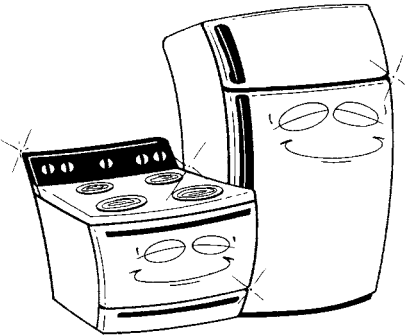

**Appliance
Parts**



**Heating
Parts**



**Plumbing
Supplies**

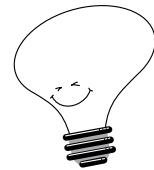

**Electrical
Supplies**

Your One Stop Source for...

Order Desk Hours Are... Monday-Friday • 7am-5pm CST

1-800-843-0903 Fax: 1-800-344-1848

www.pdqsupplyinc.com



***Where is my model number located?
See our handy model number guide
on the colored pages in the front of
this catalog.***

PRICING STARTS ON PAGE 275

All logos, trademarks, part numbers, photos & illustrations are intended solely for identification.
Items offered for sale are not represented to be manufactured by the company that built the original equipment.

PHONE: 800-843-0903

FAX: 800-344-1848

WEB: www.pdqsupplyinc.com